

VHF FM TRANSCEIVER

IC-V100

UHF FM TRANSCEIVER

IC-U400

OWNER'S MANUAL

UNPACKING

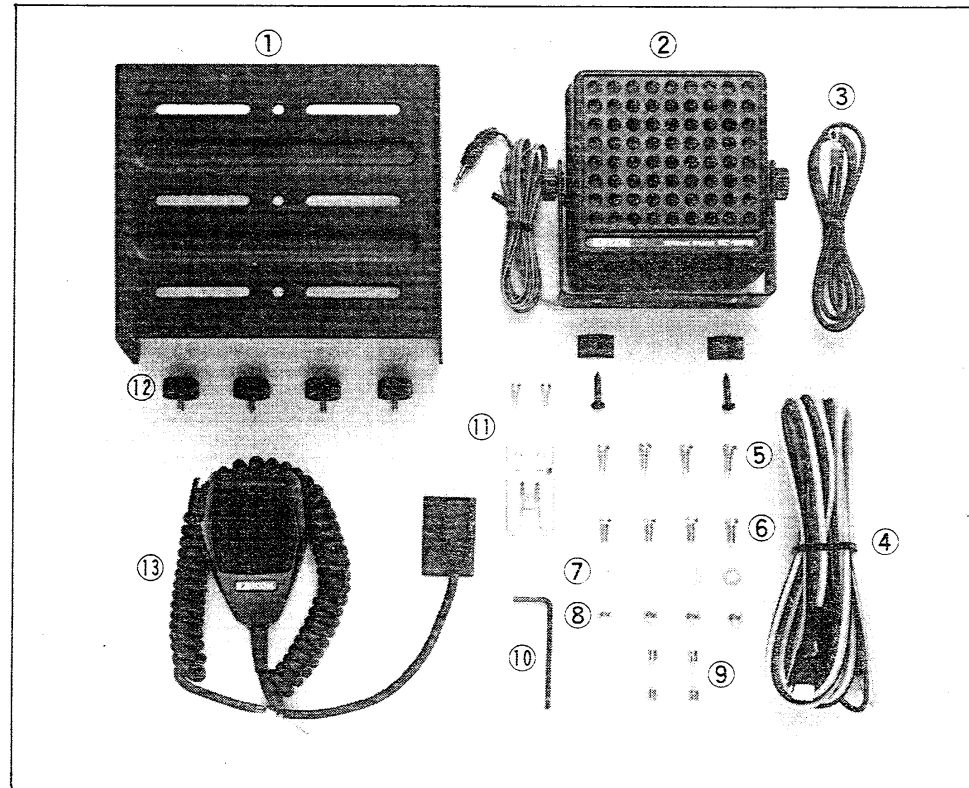

① Mounting bracket	1	⑧ Mounting nuts	4
② External speaker	1 set	⑨ Spare fuses.	2
③ Microphone hanger grounding lead	1	⑩ Allen key wrench	1
④ DC power cable.	1	⑪ Microphone hanger	1 set
⑤ Mounting self-tapping screws	4	⑫ Mounting bracket screws.	4
⑥ Mounting screws	4	⑬ Microphone	1
⑦ Flat washers	4		

FOREWORD

Thank you for your purchase of the ICOM IC-V100/IC-U400, the most technologically advanced and sophisticated VHF/UHF mobiles on the Land Mobile market today.

Utilizing sophisticated computer based technology and ICOM's precision VHF/UHF engineering, the IC-V100/IC-U400 incorporate state-of-the-art design concepts to meet the demanding needs and requirements of the Land Mobile user.

TABLE OF CONTENTS

SECTION	1	INSTALLATION	1
	1-1	VEHICLE INSTALLATION.....	1
	1-2	POWER REQUIREMENTS	2
SECTION	2	CONTROL FUNCTIONS	3
SECTION	3	OPERATION	7
	3-1	RECEIVING	7
	3-2	TRANSMITTING	8
	3-3	SELECTING CHANNELS	8
	3-4	SCANNING	9
	3-5	PROGRAMMING THE PRIORITY CHANNEL	11
	3-6	PROGRAMMING THE LOCKOUT CHANNEL	12
	3-7	MONITOR FUNCTION.....	12

SECTION 1 INSTALLATION

1 - 1 VEHICLE INSTALLATION

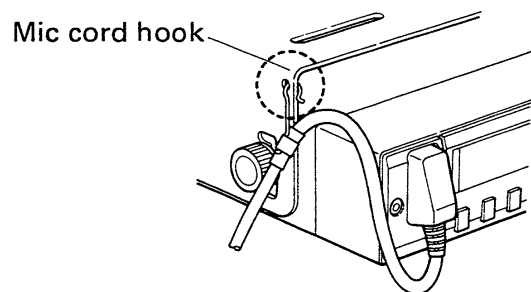

- ① Select a location which can support the weight of the unit, and does not interfere with the driver in any way.
- ② Place the mounting bracket in the mounting location and mark the bracket's screw holes. Confirm the controls and switches can be handled easily, and the display seen clearly in the selected location.
- ③ Drill the holes.
- ④ Mount the bracket as shown in the diagram. Tighten the screws.

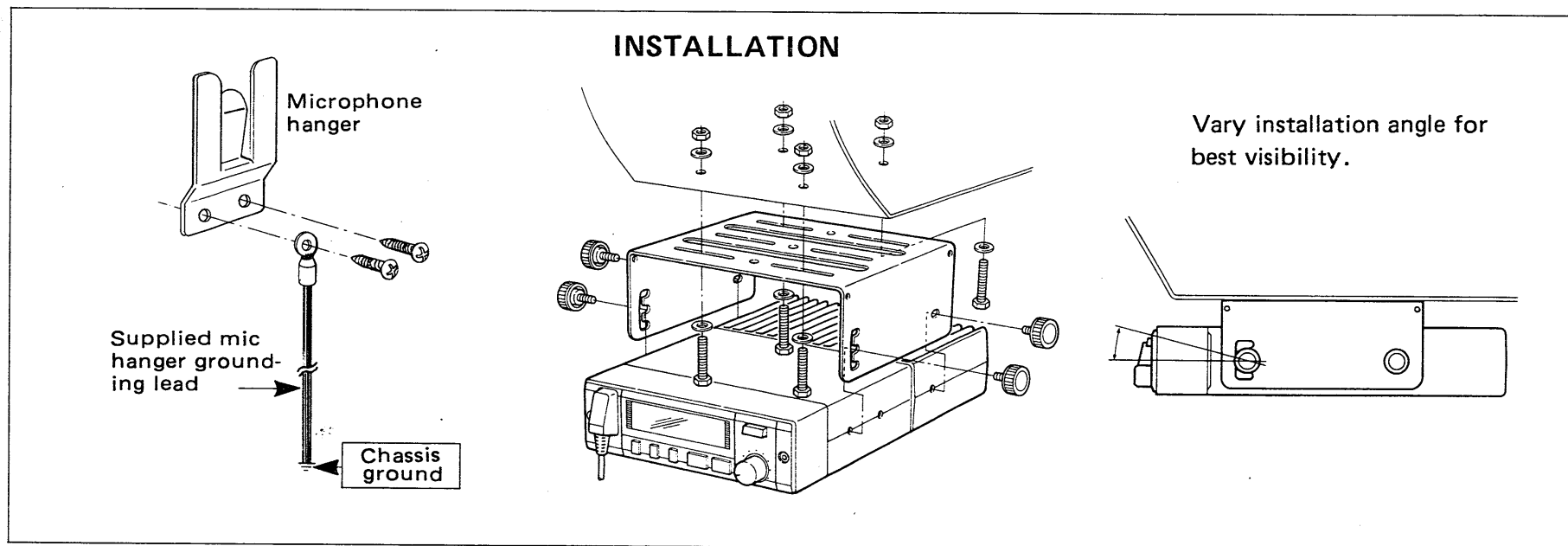

1-2 POWER REQUIREMENTS

The transceiver is supplied ready to operate from any regulated 13.8V DC, 10A negative ground source. An automobile 12 volt, negative ground system works well as a power source.

CAUTION: Voltage greater than 15 volts DC will damage your transceiver. Check the source voltage before connecting the power cable.

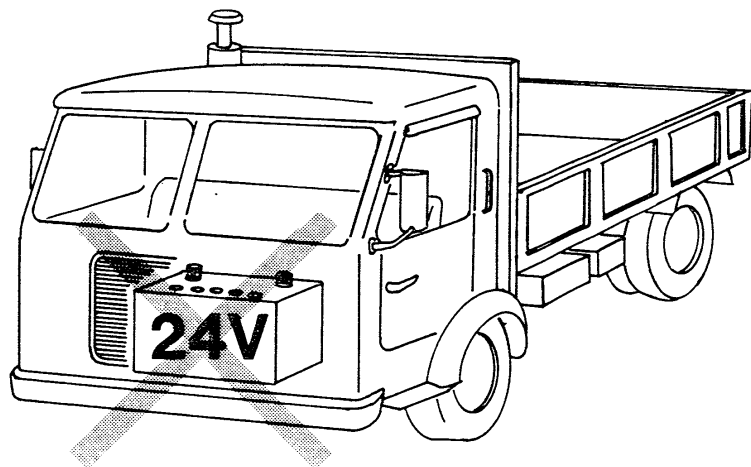

The 24V battery cannot be connected to the transceiver directly. Please ask your authorized dealer or ICOM service center if your vehicle has a 24V battery installed.

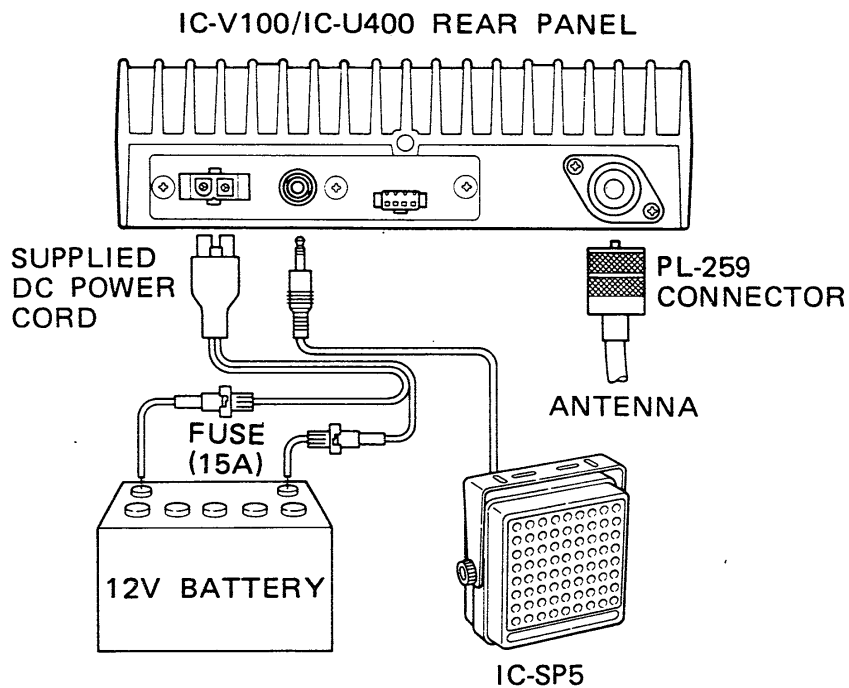

SECTION 2 CONTROL FUNCTIONS

FRONT PANEL

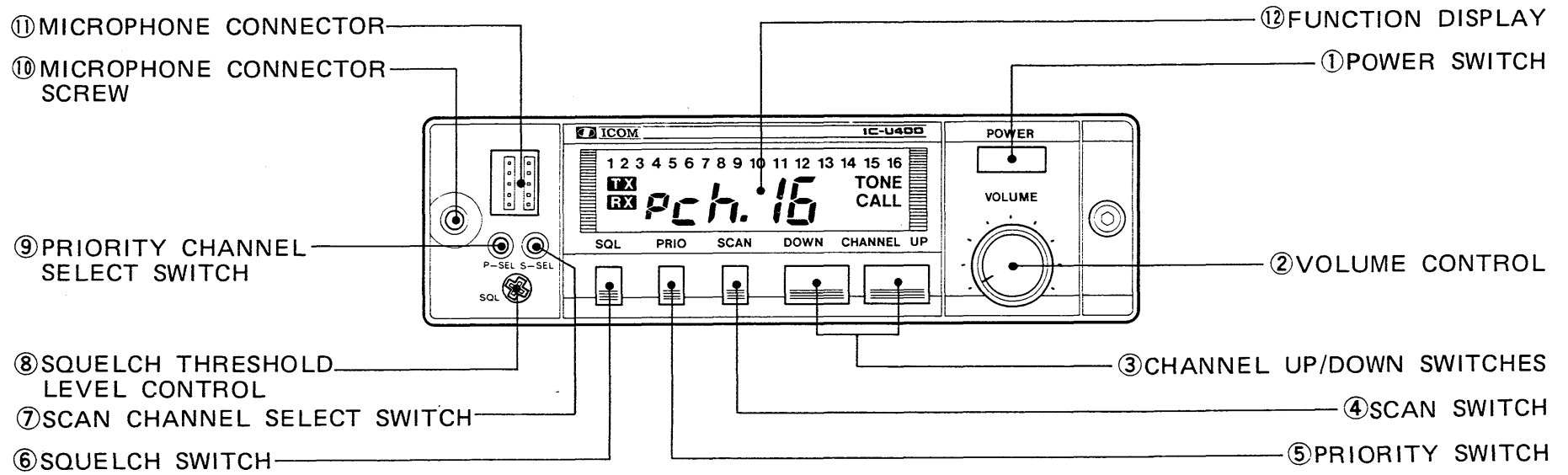

REAR PANEL

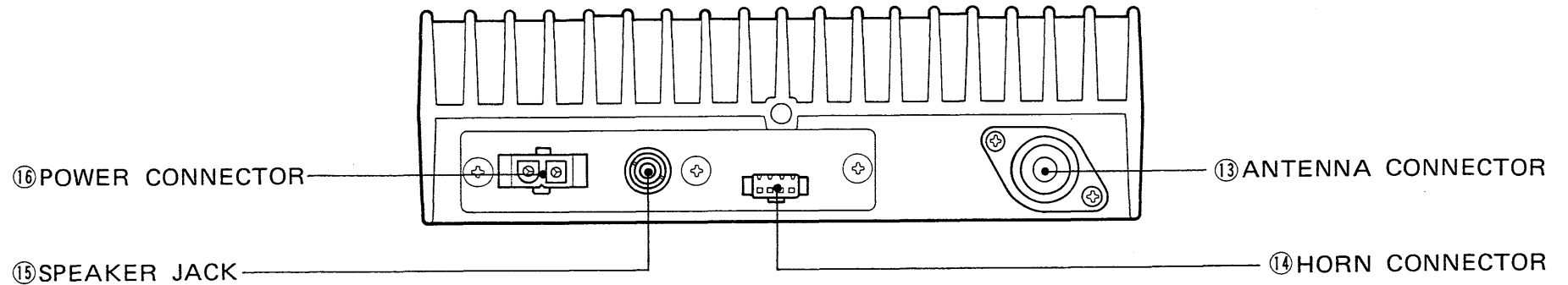

- | | |
|--|---|
| ① POWER SWITCH [POWER] | Turns the power to the transceiver ON and OFF. |
| ② VOLUME CONTROL [VOLUME] | Rotate clockwise to increase the volume level. |
| ③ CHANNEL UP/DOWN SWITCHES | Push these switches to increase or decrease the selected channel. |
| ④ SCAN SWITCH [SCAN] | Starts and stops the scan functions. The scan resumes from the channel it stopped on when this switch is pushed again. See page 9 for scanning operation. |
| ⑤ PRIORITY SWITCH [PRIO] | Push the [PRIO] SWITCH to instantly select the PRIORITY CHANNEL in order to operate or to confirm which channel has priority status. |
| ⑥ SQUELCH SWITCH [SQL] | Turns the squelch circuit ON and OFF. |
| ⑦ SCAN CHANNEL SELECT SWITCH [S-SEL] | Selects the channels to be scanned. See page 12 for scanning operation. |
| ⑧ SQUELCH THRESHOLD LEVEL CONTROL [SQL] | Sets the squelch threshold level. |
| ⑨ PRIORITY CHANNEL SELECT SWITCH [P-SEL] | Selects the priority channel. See page 11 for priority channel operation. |
| ⑩ MICROPHONE CONNECTOR SCREW | Secures the microphone connector to the front panel. |
| ⑪ MICROPHONE CONNECTOR | Connects the supplied microphone to the transceiver. |

⑫ FUNCTION DISPLAY

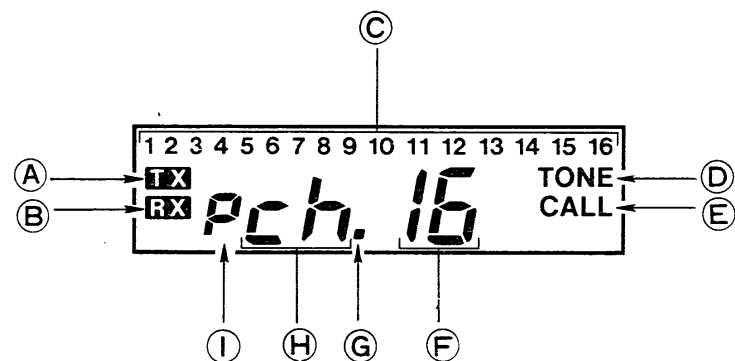

Ⓐ BUSY INDICATOR

"RX" appears when receiving a signal.

Ⓑ TRANSMIT INDICATOR

"TX" appears when transmitting.

Ⓒ SCAN CHANNEL INDICATOR

The programmed channel numbers "1, 2, 3.....16" appear. The priority channel blinks when scanning.

Ⓓ TONE INDICATOR

"TONE" appears when an individual tone is programmed to operate on one of the channels.

Ⓔ CALL INDICATOR

"CALL" appears when a signal is received with the same individual tone as is programmed in the transceiver.

Ⓕ CHANNEL NUMBER INDICATOR

Displays the operating channel.

Ⓖ STEP SCAN INDICATOR

Blinks when the transceiver is scanning in the STEP SCAN.

Ⓗ CHANNEL INDICATOR

Displays "ch" which represents the word "channel".

Ⓘ PRIORITY INDICATOR

Displays that the channel is the priority channel.

⑬ ANTENNA CONNECTOR

Connect an antenna connector here.

CAUTION: Transmitting without an antenna may damage the transmitter.

⑭ HORN CONNECTOR

Connects to an external horn which acts as an alarm. A vehicle horn may be used for this purpose when an optional UT-26 2-TONE DECODER UNIT or UT-27 2805Hz TONE DECODER UNIT is installed.

⑮ SPEAKER JACK

Connects to the supplied IC-SP5 speaker.

⑯ POWER CONNECTOR

Connects to the supplied power cable.

SECTION 3 OPERATION

3 - 1 RECEIVING

- ① Push [POWER] SWITCH ON.

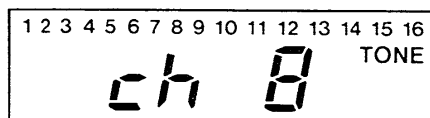

- ② Push [SQUELCH] SWITCH and adjust [VOLUME] CONTROL.

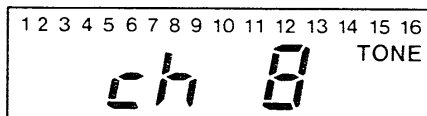

- ③ Push [SQUELCH] SWITCH again.

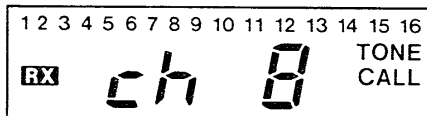

- ④ Signal received on channel 8.

Verify that the [POWER] SWITCH is OFF and the microphone is in the microphone hanger before connecting power to the transceiver.

- ① Push the [POWER] SWITCH ON (IN position).

- ② Push the [SQL] SWITCH OFF ("RX" appears on the display). Rotate the [VOLUME] CONTROL clockwise for a comfortable listening level.

- ③ Push the [SQL] SWITCH ON ("RX" disappears). The transceiver now remains silent until a signal is received which opens the receiver's squelch circuit.

- ④ When a signal is received, on channel 8 for example, "RX", "TONE" and "CALL" INDICATORS appear.

NOTE: If no individual tone is programmed for channel 8, "TONE" and "CALL" do not appear.

3 - 2 TRANSMITTING

- ① Press [PTT] SWITCH.

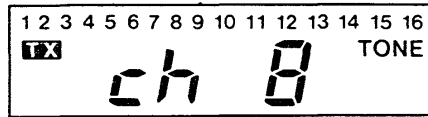

- ② Speak into the microphone.

- ③ Release [PTT] SWITCH.

3 - 3 SELECTING CHANNELS

- ① Push [UP] SWITCH.

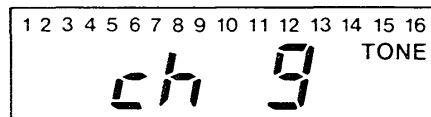

DOWN CHANNEL UP



- ② Use either the [UP] or [DOWN] SWITCHES.

- ① Press the [PTT] (push-to-talk) SWITCH to begin transmitting. "TX" and "TONE" appear on the display to indicate a signal is being transmitted.

NOTE: If no individual tone is programmed, "TONE" does not appear.

- ② Speak into the microphone using your normal voice level.

- ③ Release the [PTT] SWITCH to return to the receive mode.

Channels may be selected by using the CHANNEL [UP]/[DOWN] SWITCHES.

- ① Push the [UP] SWITCH once. The displayed channel number increases by one and the transceiver is ready to transmit and receive on this new channel.

- ② To increase or decrease the operating channel number, push the [UP] or [DOWN] SWITCH respectively, or hold the keys down to continuously shift upwards or downwards through the channels.

3 - 4 SCANNING

The IC-V100/IC-U400 provides either PRIORITY SCAN or STEP SCAN. These scan functions can be set by your nearest authorized ICOM Dealer to suit your operating purposes.

SCAN: Eliminates the need for channel searching by automatically monitoring programmed channels. The scan will stop at a channel on which a signal is received.

The method of scanning in both PRIORITY SCAN and STEP SCAN is the same. See page 10 for detailed information.

- 1) Adjust [VOLUME] CONTROL and push [SQUELCH] SWITCH.

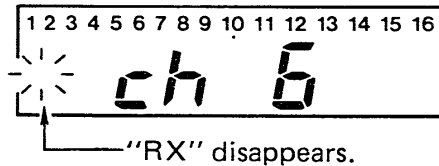

- 2) Push the [SCAN] SWITCH.
- 3) The scan will stop when the transceiver receives a signal.

- 1) Adjust the [VOLUME] CONTROL and push the [SQL] SWITCH to close the squelch. "RX" should disappear from the FUNCTION DISPLAY.

- 2) Push the [SCAN] SWITCH to start the scan.
 - Push the [SCAN] SWITCH again to stop the scan.
- 3) The scan will stop to monitor only channels which have communication on them.
- 4) See page 10 for information regarding making a transmission while scanning.

(1) Priority scan note

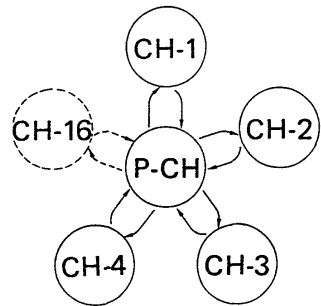

P-CH: Priority Channel

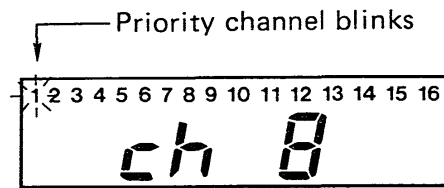

(2) Step scan note

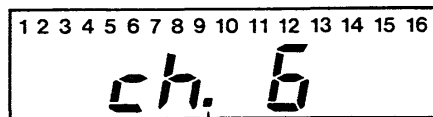
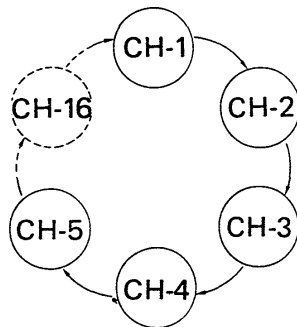

Decimal point blinks

The priority channel feature allows easy monitoring of your most important channel while still listening for signals on the other programmed channels.

- ① The small number at the top of the FUNCTION DISPLAY is the priority channel number. The priority channel can be changed to suit your operating purposes.
- ② If you have a call from a station, push the [SCAN] SWITCH to cancel scanning. Transmitting can be performed on the called channel.
- ③ When transmitting while the transceiver is scanning, the transmit channel is always the same as the user-programmed priority channel.

Repeatedly scans all programmed channels in sequence. The scan will stop at any channel on which a signal is received.

- ① The decimal point between the "ch" and channel number on the FUNCTION DISPLAY blinks during STEP SCAN.
 - The IC-V100/IC-U400 allows you to selectively choose which channels the scanning function will monitor.
- ② If you have a call from a station, push the [PTT] SWITCH to cancel scanning on the called channel. Transmitting can be performed on the called channel.

3 - 5 PROGRAMMING THE PRIORITY CHANNEL

- ① Remove the microphone connector.

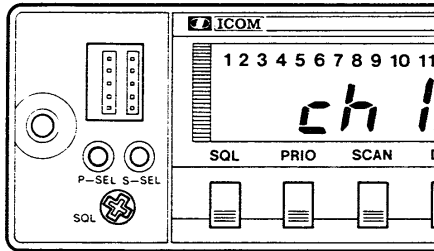

- ② Select priority channel. Push [P-SEL] SWITCH.

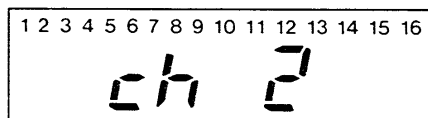

- ③ Push [PRIO] SWITCH to check the priority channel.

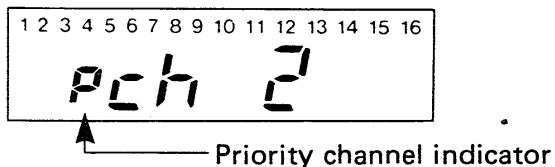

- ④ Replace the microphone connector.

NOTE: The priority channel cannot be programmed when **STEP SCAN** has been set in the transceiver. A small number at the top of the **FUNCTION DISPLAY** appears when **PRIORITY SCAN** has been set.

- ① Remove the microphone connector from the transceiver front panel by using the supplied allen key wrench.

- ② Select a channel using the [UP]/[DOWN] SWITCHES, then push [P-SEL] SWITCH to program the selected channel with priority status.

- ③ Push the [PRIO] SWITCH to confirm the priority channel is correct. Note that the priority indicator appears beside the "ch" indicator.

- ④ Replace the microphone connector to the front panel by using the supplied allen key wrench.

3 - 6 PROGRAMMING THE LOCKOUT CHANNEL

① Remove microphone connector.

② Select channel.
(Example):
Select channel 7 for lockout.

③ Push [S-SEL] SWITCH.

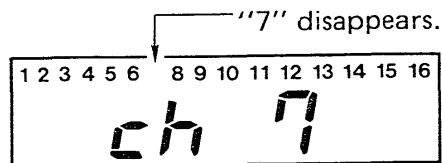

④ Push [S-SEL] SWITCH again to return to the normal operating channel.

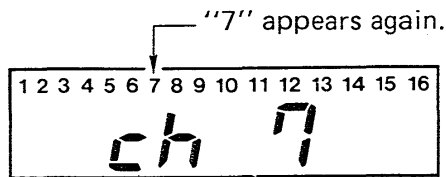

3 - 7 MONITOR FUNCTION

LOCKOUT FUNCTION:

The purpose of the lockout function is to disable specific channels so, when scanning, the transceiver does not stop on these channels.

① Remove the microphone connector from the transceiver front panel using the supplied allen key wrench.

② Select the channel you wish to delete from or add to the scan channels by using the [UP]/[DOWN] SWITCHES.

③ Push the [S-SEL] SWITCH to lock out the channel.

- The small channel number disappears from the display and this channel will now be skipped during scanning.

④ Push the [S-SEL] SWITCH again to cancel the lockout. The scan will now include this channel.

The monitor function allows you to listen to a busy channel when the microphone is removed from its hanger regardless of which tone system (CTCSS, 2-TONE, 2805Hz) is in use on that channel.

The optional HG-10 MIC HANGER BOX is available. The box provides monitoring of any channel when operating with the tone squelch function ON even if the microphone is left hanging on the mic hanger.

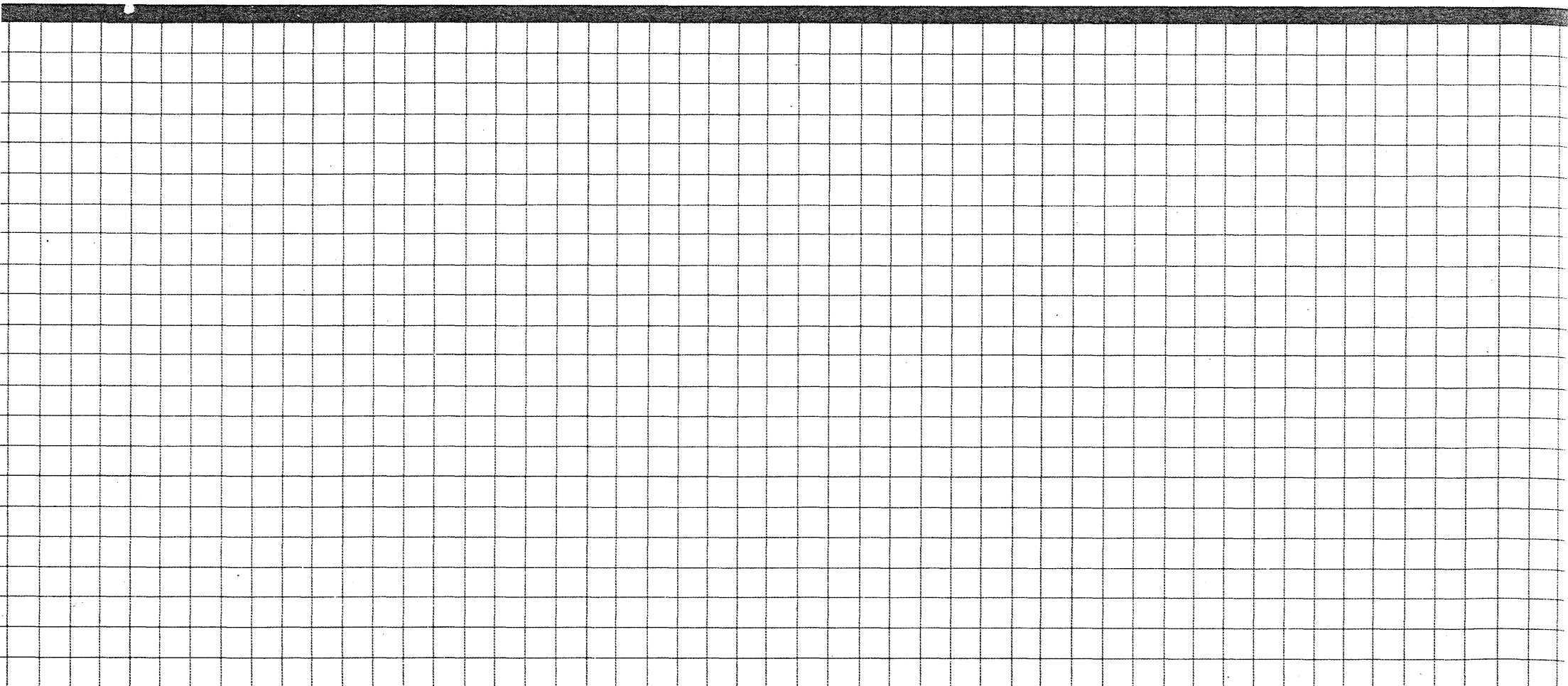

ICOM INCORPORATED

1-6-19, KAMIKURATSUKURI, HIRANO-KU,
OSAKA 547, JAPAN

A-0886

Printed in Japan